

## Power SMD LED CLCC-2 Flat

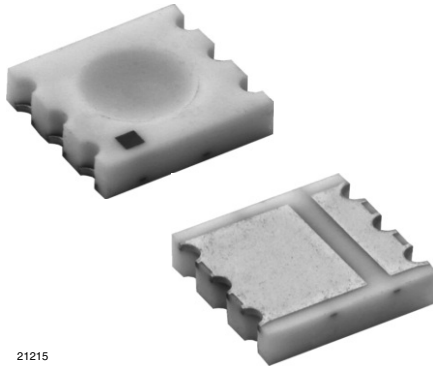

21215

### DESCRIPTION

The VLMW84.. is one of the most robust and light efficient LEDs in the market. The small size and wide viewing angle make these LEDs a prime choice for backlighting applications and front panel indicators, especially where space is at a premium. Its ceramic package makes it the ideal light source in applications of high thermal considerations allowing the additional current drive for a maximum light output while maintaining a high service life of up to 50 kh. The reflector inside this package is filled with a mixture of silicone and TAG phosphor. The TAG phosphor converts the blue emission partially to yellow, which mixes with the remaining blue to white.

### PRODUCT GROUP AND PACKAGE DATA

- Product group: LED
- Package: SMD CLCC-2 flat
- Product series: power
- Angle of half intensity:  $\pm 60^\circ$

### FEATURES

- Utilizing InGaN technology
- Very low thermal resistance, high optical power
- Optical efficiency 40 lm/W at 100 mA
- Luminous intensity and color grouping
- Luminous intensity ratio per package unit  $I_{Vmax}/I_{Vmin} \leq 1.6$
- ESD-withstand voltage: up to 1 kV according to JESD22-A114-B
- Compatible with IR reflow solder processes according to CECC 00802 and J-STD-020C
- Lead (Pb)-free device
- Component in accordance to RoHS 2002/95/EC and WEEE 2002/96/EC
- Preconditioning: acc. to JEDEC level 4
- Automotive qualified AEC-Q101
- Very flat package (0.75 mm)



### APPLICATIONS

- Camera flash light
- Interior and exterior automotive lighting: brake lights, turn lights, backlighting, side markers
- Indicator lighting
- Signal and symbol luminaire
- Marker lights
- Dashboard illumination

### PARTS TABLE

PART	COLOR, LUMINOUS INTENSITY (at $I_F = 350 \text{ mA}$ )	LUMINOUS FLUX (TYP.)	TECHNOLOGY
VLMW84DBFA-08	White, $I_V = (5600 \text{ to } 14\ 000) \text{ mcd}$	27 000 mlm	InGaN/TAG
VLMW84DBFA-18	White, $I_V = (5600 \text{ to } 14\ 000) \text{ mcd}$	27 000 mlm	InGaN/TAG

ABSOLUTE MAXIMUM RATINGS <sup>1)</sup> VLMW84..				
PARAMETER	TEST CONDITION	SYMBOL	VALUE	UNIT
Forward current		$I_F$	350	mA
Power dissipation		$P_{tot}$	1750	mW
Junction temperature		$T_j$	+ 125	°C
Surge current $t < 10 \mu s, d = 0.1$		$I_{FM}$	1000	mA
Operating temperature range		$T_{amb}$	- 40 to + 100	°C
Storage temperature range		$T_{stg}$	- 40 to + 100	°C
Thermal resistance junction/pin	Metal core pcb 960 mm <sup>2</sup> per LED	$R_{thJP}$	25	K/W

Note:

Not designed for reverse operation

<sup>1)</sup>  $T_{amb} = 25 \text{ °C}$ , unless otherwise specified

OPTICAL AND ELECTRICAL CHARACTERISTICS <sup>1)</sup> VLMW84.., WHITE							
PARAMETER	TEST CONDITION	PART	SYMBOL	MIN.	TYP.	MAX.	UNIT
Luminous intensity	$I_F = 350 \text{ mA}$	VLMW84DBFA	$I_V$	5600		14 000	mcd
Luminous flux calculated	$I_F = 350 \text{ mA}$	VLMW84DBFA	$\phi_V$	17 600		44 000	mlm
Chromaticity coordinate x acc. to CIE 1931	$I_F = 350 \text{ mA}$		x		0.33		
Chromaticity coordinate y acc. to CIE 1931	$I_F = 350 \text{ mA}$		y		0.33		
Angle of half intensity	$I_F = 350 \text{ mA}$		$\phi$		$\pm 60$		deg
Forward voltage	$I_F = 350 \text{ mA}$		$V_F$	3.5	4.0	5.0	V
Temperature coefficient of $V_F$	$I_F = 350 \text{ mA}$		$TC_{VF}$		- 3		mV/K
Temperature coefficient of $I_V$	$I_F = 350 \text{ mA}$		$TC_{IV}$		- 0.4		%/K

Note:

Not designed for reverse operation

<sup>1)</sup>  $T_{amb} = 25 \text{ °C}$ , unless otherwise specified

LUMINOUS INTENSITY/FLUX CLASSIFICATION WHITE		
GROUP	LUMINOUS INTENSITY IV (mcd)	
STANDARD	MIN.	MAX.
DB	5600	7100
EA	7100	9000
EB	9000	11 200
FA	11 200	14 000

Note:

Luminous intensity is tested at a current pulse duration of 25 ms and an accuracy of  $\pm 11 \%$ .

The above type Numbers represent the order groups which include only a few brightness groups. Only one group will be shipped on each reel (there will be no mixing of two groups on each reel).

In order to ensure availability, single brightness groups will not be orderable.

In a similar manner for colors where wavelength groups are measured and binned, each single wavelength group is packed in a single reel.

In order to ensure availability, single wavelength groups can not be ordered.

FORWARD VOLTAGE CLASSIFICATION		
GROUP	FORWARD VOLTAGE (V)	
	MIN.	MAX.
4	3.5	4.3
5	4.3	5.0

Note:

Forward voltages are tested at a current pulse duration of 25 ms and a tolerance of  $\pm 0.1 \text{ V}$ .

In order to ensure availability, a single forward voltage group can not be ordered.

CHROMATICITY COORDINATED GROUPS FOR WHITE SMD LED						
		X	Y			
5		0.272	0.302	7		
		0.303	0.329			
		0.313	0.284			
		0.296	0.259			
6		0.300	0.345	8		
		0.330	0.370			
		0.330	0.310			
		0.313	0.284			

Note:

Chromaticity coordinate groups are tested at a current pulse duration of 25 ms and a tolerance of  $\pm 0.01$ .

### TYPICAL CHARACTERISTICS

$T_{amb} = 25\text{ }^{\circ}\text{C}$ , unless otherwise specified

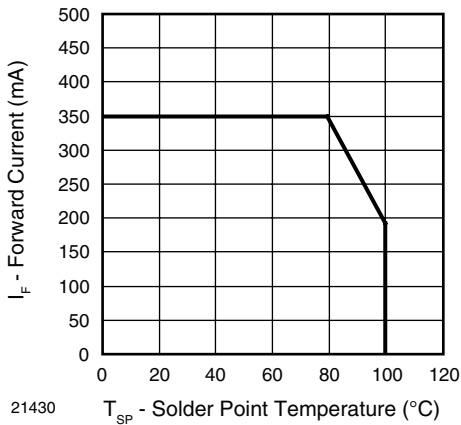

Figure 1. Permissible Forward Current vs. Solder Point Temperature

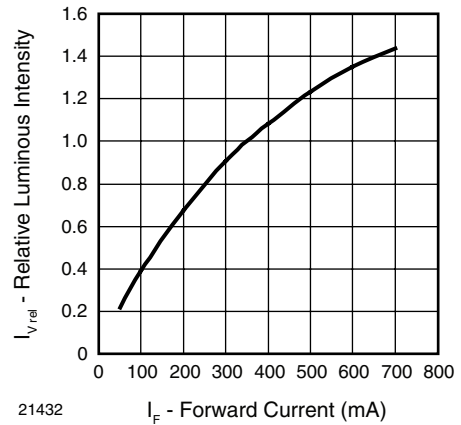

Figure 3. Relative Luminous Intensity vs. Forward Current

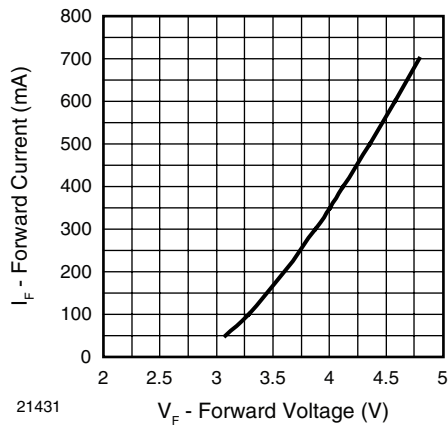

Figure 2. Forward Current vs. Forward Voltage

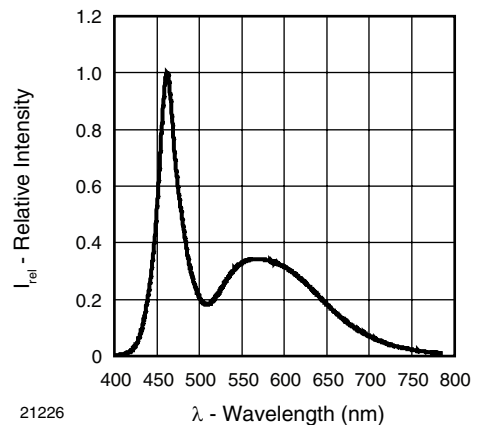

Figure 4. Relative Intensity vs. Wavelength

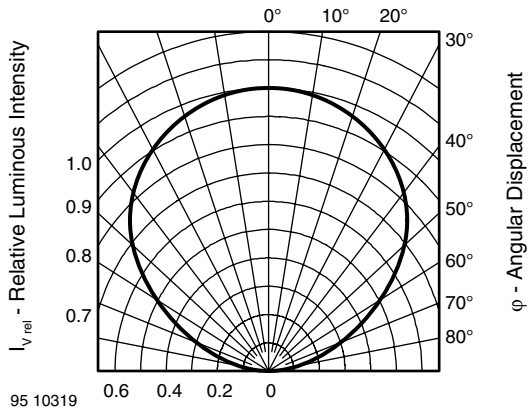

Figure 5. Relative Luminous Intensity vs. Angular Displacement

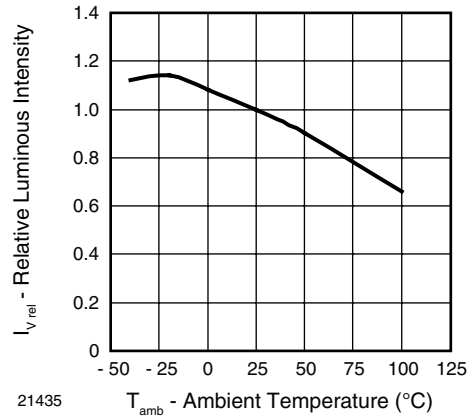

Figure 8. Relative Luminous Intensity vs. Ambient Temperature

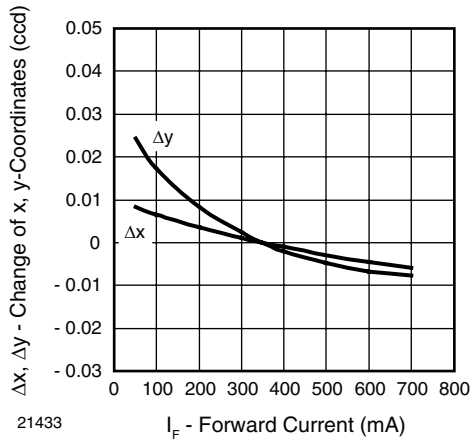

Figure 6. Change of x, y-Coordinates vs. Forward Current

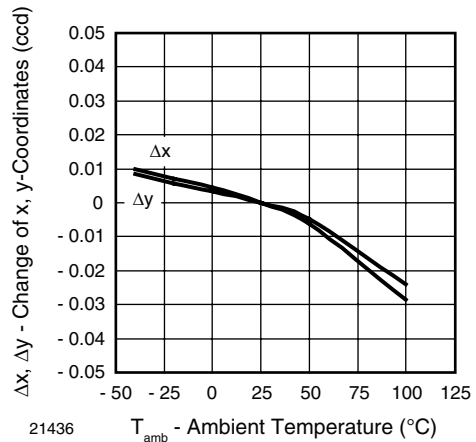

Figure 9. Change of x-Coordinates vs. Ambient Temperature

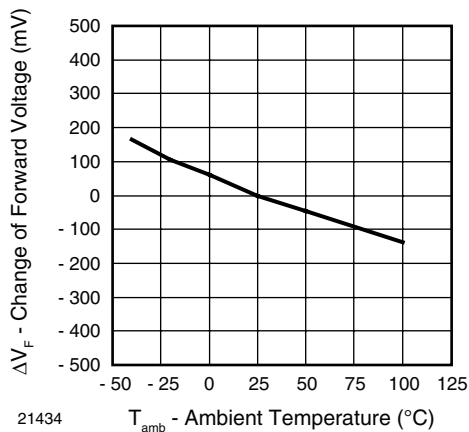

Figure 7. Change of Forward Voltage vs. Ambient Temperature

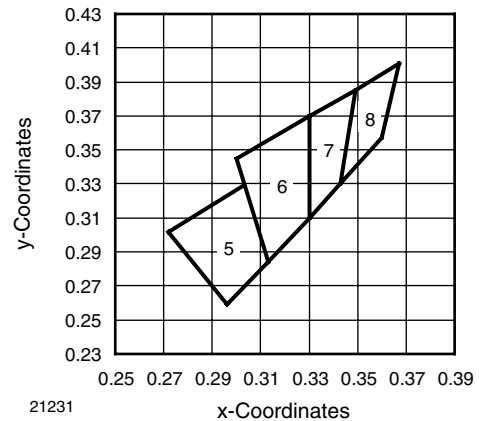
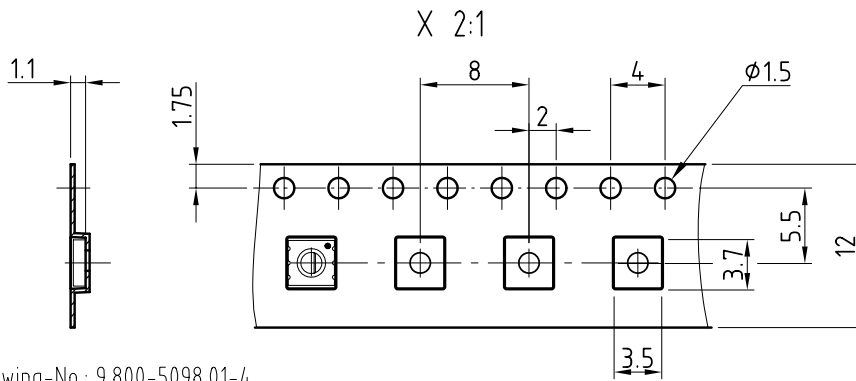
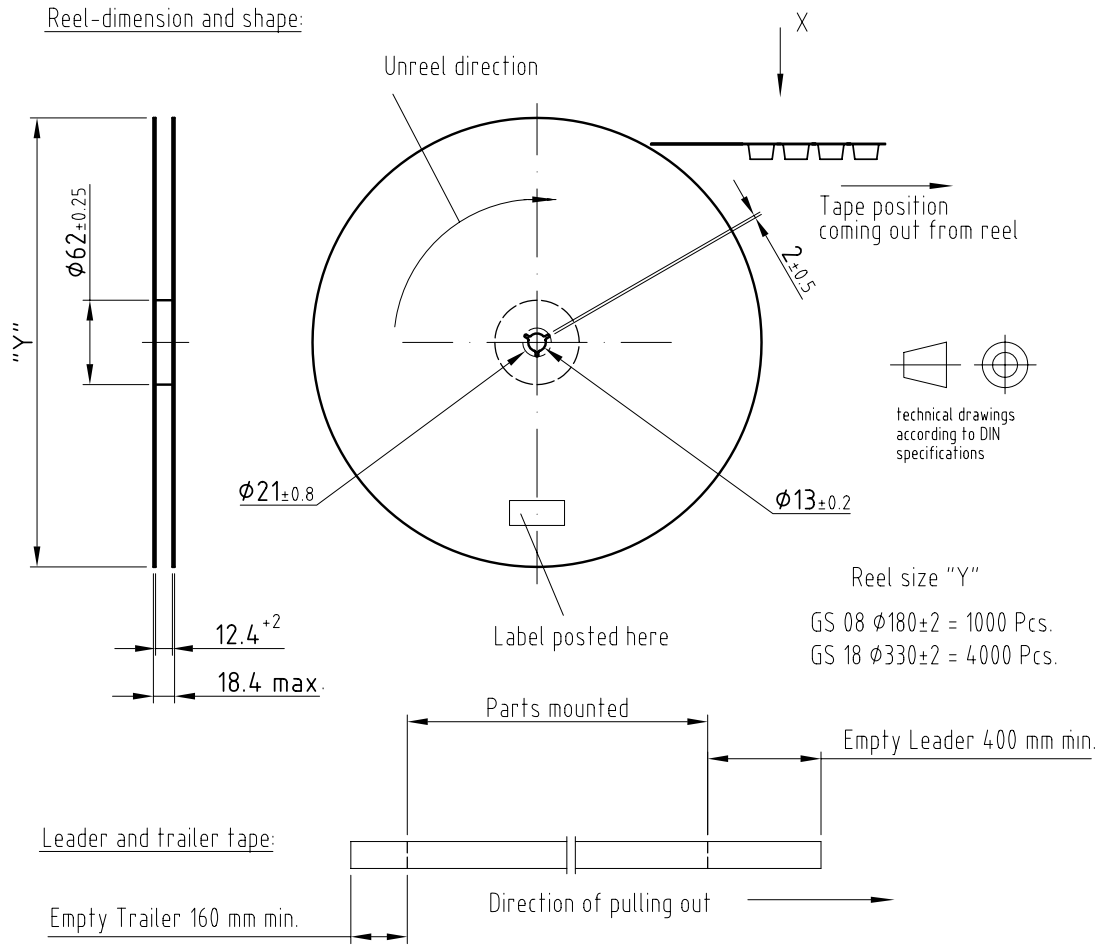

Figure 10. Coordinates of Colorgroups

**TAPING DIMENSIONS** in millimeters



Drawing-No.: 9.800-5098.01-4  
Issue: 1; 17.09.07  
20869

**PACKAGE DIMENSIONS** in millimeters

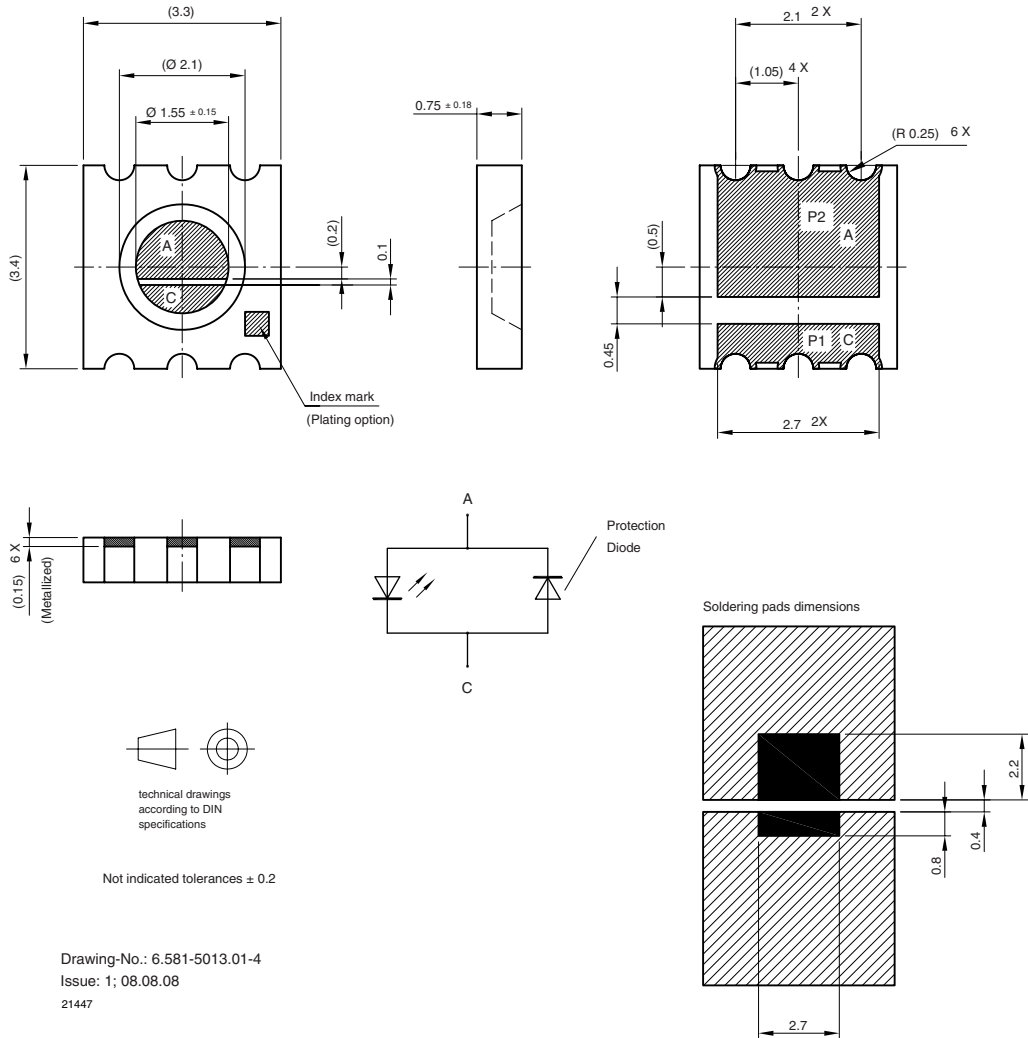

**SOLDERING PROFILE**

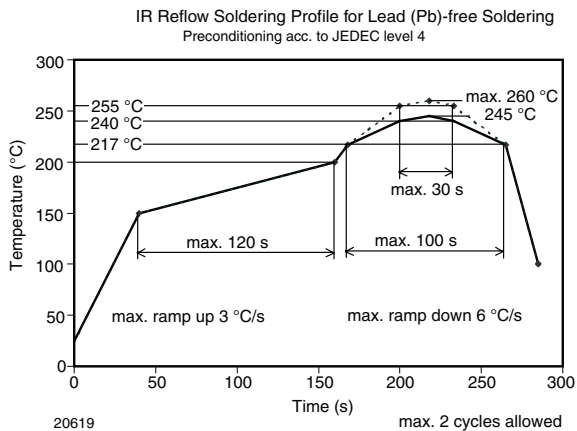
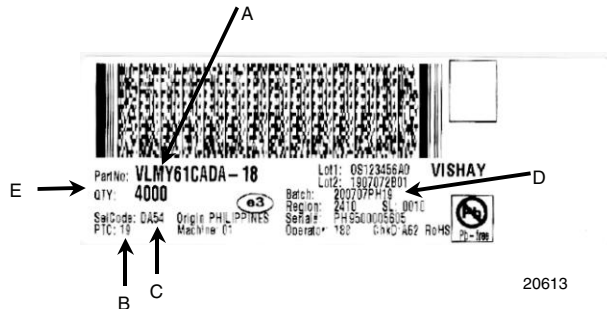

Figure 11. Vishay Lead (Pb)-free Reflow Soldering Profile (acc. to J-STD-020C)

**BAR CODE PRODUCT LABEL  
EXAMPLE:**

- A) Type of component  
 B) Manufacturing plant  
 C) SEL - selection code (bin):  
 e.g.: DA = code for luminous intensity group  
 5 = code for color group  
 4 = code for forward voltage  
 D) Batch:  
 200707 = year 2007, week 07  
 PH19 = plant code  
 E) Total quantity

**DRY PACKING**

The reel is packed in an anti-humidity bag to protect the devices from absorbing moisture during transportation and storage.

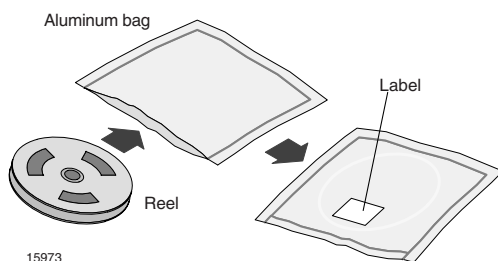
**FINAL PACKING**

The sealed reel is packed into a cardboard box. A secondary cardboard box is used for shipping purposes.

**RECOMMENDED METHOD OF STORAGE**

Dry box storage is recommended as soon as the aluminum bag has been opened to prevent moisture absorption. The following conditions should be observed, if dry boxes are not available:

- Storage temperature 10 °C to 30 °C
- Storage humidity ≤ 60 % RH max.

After more than 72 h under these conditions moisture content will be too high for reflow soldering.

In case of moisture absorption, the devices will recover to the former condition by drying under the following condition:

192 h at 40 °C + 5 °C/- 0 °C and < 5 % RH (dry air/nitrogen) or

96 h at 60 °C + 5 °C and < 5 % RH for all device containers or

24 h at 100 °C + 5 °C not suitable for reel or tubes.

An EIA JEDEC standard JESD22-A112 level 4 label is included on all aluminum dry bags.

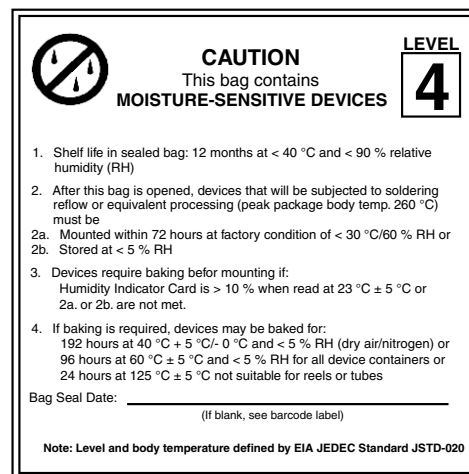

Example of JESD22-A112 level 4 label

**ESD PRECAUTION**

Proper storage and handling procedures should be followed to prevent ESD damage to the devices especially when they are removed from the antistatic shielding bag. Electro-static sensitive devices warning labels are on the packaging.

**VISHAY SEMICONDUCTORS STANDARD  
BAR CODE LABELS**

The Vishay Semiconductors standard bar code labels are printed at final packing areas. The labels are on each packing unit and contain Vishay Semiconductors specific data.

**OZONE DEPLETING SUBSTANCES POLICY STATEMENT**

It is the policy of Vishay Semiconductor GmbH to

1. Meet all present and future national and international statutory requirements.
2. Regularly and continuously improve the performance of our products, processes, distribution and operating systems with respect to their impact on the health and safety of our employees and the public, as well as their impact on the environment.

It is particular concern to control or eliminate releases of those substances into the atmosphere which are known as ozone depleting substances (ODSs).

The Montreal Protocol (1987) and its London Amendments (1990) intend to severely restrict the use of ODSs and forbid their use within the next ten years. Various national and international initiatives are pressing for an earlier ban on these substances.

Vishay Semiconductor GmbH has been able to use its policy of continuous improvements to eliminate the use of ODSs listed in the following documents.

1. Annex A, B and list of transitional substances of the Montreal Protocol and the London Amendments respectively.
2. Class I and II ozone depleting substances in the Clean Air Act Amendments of 1990 by the Environmental Protection Agency (EPA) in the USA.
3. Council Decision 88/540/EEC and 91/690/EEC Annex A, B and C (transitional substances) respectively.

Vishay Semiconductor GmbH can certify that our semiconductors are not manufactured with ozone depleting substances and do not contain such substances.

The IEC/EN standards require that the desired classification Accessible Emission Limit shall not be exceeded in "Normal" and "Single Fault Conditions". This product is in Compliance with the requirement in CEN/IEC/EN60825-1 to ensure that required classifications are not exceeded in single fault conditions.

We reserve the right to make changes to improve technical design  
and may do so without further notice.

Parameters can vary in different applications. All operating parameters must be validated for each customer application by the customer. Should the buyer use Vishay Semiconductors products for any unintended or unauthorized application, the buyer shall indemnify Vishay Semiconductors against all claims, costs, damages, and expenses, arising out of, directly or indirectly, any claim of personal damage, injury or death associated with such unintended or unauthorized use.

Vishay Semiconductor GmbH, P.O.B. 3535, D-74025 Heilbronn, Germany





## Disclaimer

All product specifications and data are subject to change without notice.

Vishay Intertechnology, Inc., its affiliates, agents, and employees, and all persons acting on its or their behalf (collectively, "Vishay"), disclaim any and all liability for any errors, inaccuracies or incompleteness contained herein or in any other disclosure relating to any product.

Vishay disclaims any and all liability arising out of the use or application of any product described herein or of any information provided herein to the maximum extent permitted by law. The product specifications do not expand or otherwise modify Vishay's terms and conditions of purchase, including but not limited to the warranty expressed therein, which apply to these products.

No license, express or implied, by estoppel or otherwise, to any intellectual property rights is granted by this document or by any conduct of Vishay.

The products shown herein are not designed for use in medical, life-saving, or life-sustaining applications unless otherwise expressly indicated. Customers using or selling Vishay products not expressly indicated for use in such applications do so entirely at their own risk and agree to fully indemnify Vishay for any damages arising or resulting from such use or sale. Please contact authorized Vishay personnel to obtain written terms and conditions regarding products designed for such applications.

Product names and markings noted herein may be trademarks of their respective owners.